

Varenummer: 23017771124
 Beskrivelse: E+G Håndhjul
 VR.250 FP-A24

Mål

VR.FP-A

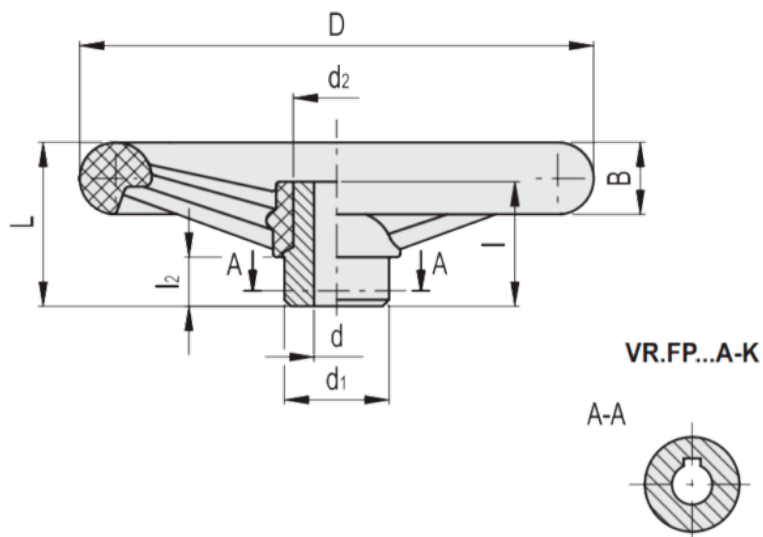

B	= 30	l	= 44
b	= 8	L	= 66
C (N*m)	= 405	L (J)	= 19
D	= 247	l2	= 15
d1	= d15	t	= 30.3
d2	= 38		
d'	= 34		
d''	= 27		